



Bistable miniature relay TRK 15, TRK 16



- Small dimensions 15.6 x 10.2 x 11.5 mm
- Coil energizing by DC voltage impulse
- Non-flammable material V- 0
- Max. contact current 1.25 A or 3 A
- Direct instalation on PCB
- Ambient temperature up to +70°C
- Washable version Qc/2
- Plastic bars packing

Application

TRK 15, TRK 16 are neutral, bistable, remanent, electromagnetic relays for DC coil energizing with one contact system. The great advantage of the bistable relays over monostable lies in continuous operating without energizing. Bistable relays shall be energized with a brief DC voltage impulse, this saves coil energy and reduces operating costs. The self-heating of this relays no longer needs to be taken into consideration, what also enables high density of electronics components on PC board. Furthermore, if the power supply voltage fails, the switching status is maintained.

As a switching element with ability of galvanic separation it is designed to control devices with medium power consumption. It can be soldered directly into the printed circuit board used in industrial equipment, bureau appliances, data processing, automotive industry, safety devices and for general purposes.

In case of full load on contacts and operating with max. switching rate and max. ambient temperature it is recommended to open the vent hole provided for this purpose after the relay is mounted on the PCB and the cleaning process is completed.

Technical Data

Operating

The remanent relay has a core with high-retentivity remanence material. When the operating voltage is applied to the coil of relay the remanent core becomes magnetic saturated what causes picking-up the armature and closing the normally-open contact. After the energizing voltage fails, the residual magnetism in the core attracts the armature forward and holds the normally-open contact closed. When the core is demagnetized with the voltage of opposite polarity, the continual force of the contact spring releases the relay armature and closes the normally-close contact again. The voltage for demagnetization must be approximately one third as great as the voltage for operating. Connecting of this relay is possible in several different ways, examples are shown in the drawing of recommended drive circuit.

Contact data

Form	1 Change-over , 1 Make , 1 Break	
Contact material	AgNi10	Ag Ni10+AuAg8
Rated current	3 A	1.25 A
Max. operating voltage	120 VAC, DC	
Max. switching power	250 VA, 70 W(s.d)	150 VA, 60 W (s.d)
Min. switching load	5 VDC , 100 mA	10 mVDC, 10 μ A
Contact resistance: (New relay)	≤ 100 m Ω 100mA, 24 V _{DC}	≤ 50 m Ω 10 mA, 30 mV
Capacitance cont.-cont.	$\leq 1,5$ pF	
Max. operating frequency rated load min. load	600 oper./ h 36000 oper./ h	1800 oper./ h 36000 oper./ h
Mechanical life	$> 2 \times 10^7$ operations	
Electrical life	CO contact at 70°C (s.d) see diagrams	

Coils data for continuous energizing

Coil rated voltage	Coil resistance at 20°C	Operative voltage range at 20°C			Resistor for release E12 / 0.5W
		Must operate	Non release	Must release	
Un (Vdc)	Rn(Ω) $\pm 10\%$	Uop \leq (Vdc)	Unr \geq (Vdc)	Ure \sim (Vdc)	R(Ω) $\pm 5\%$
1.5	2.2	1.13	- 0.045	- 0.37	3.9
3	9	2.25	- 0.09	- 0.75	15
5	25	3.75	- 0.15	- 1.25	47
6	36	4.5	- 0.18	- 1.5	68
9	81	6.75	- 0.27	- 2.25	150
12	144	9	- 0.36	- 3	330
24	570	18	- 0.72	- 6	1000
48	2100	36	- 1.44	- 12	3900
60	3300	45	- 1.8	- 15	6800

Coil data for energizing at 20°C

Rated power: abt. 1W
 Thermal resistance: abt. 100 K/W
 Max. coil temperature: 155° C
 Operate voltage (cold coil): Uop $\leq 75\%$ Un
 Non release voltage: Unr $\geq 3\%$ (- Un)
 Release voltage: Ure $\sim 25\%$ (-Un)
 Ure max = 45% (-Un)
 Operative range: class 1, IEC 61810-1

Operative voltage range at different temperatures

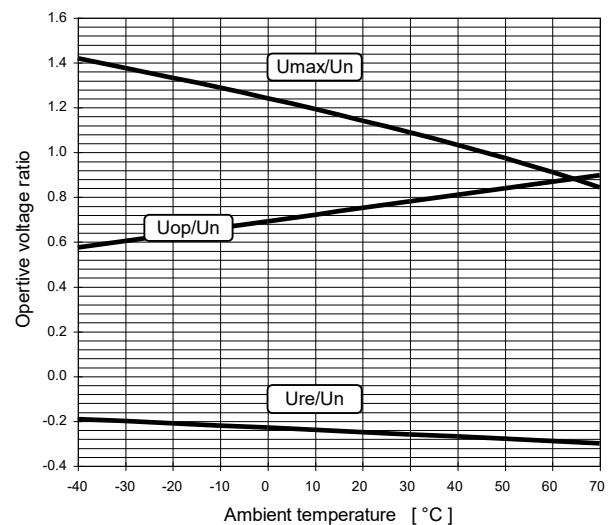
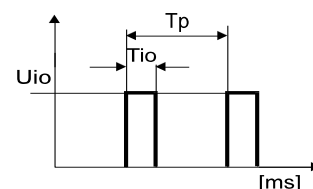

Diagram of operative voltage range shows that over 40°C of ambient temperature Umax for continuous operate duty, which still prevent overheating of the coil, becomes lower than Un. Therefore, over this temperature, impulse excitation is obligatory with impulse operate voltage Uio \geq Un.

Impulse coil voltage must not exceed 80% of the test voltage between coil windings.

Impulse coil energizing



Uio - impulse operate voltage (V)
 Tio - impulse operate duration (ms)
 Tp - periode duration (ms)

Impulse coil voltage for operating U_{io} can be higher than rated voltage U_n , but duration of the operate impulse T_{io} should be chosen from the following diagram. The best energizing is achieved with rectangular impulse in duration of 20 ms.

Impulse coil voltage for releasing U_{ir} must be opposite polarity as operate coil voltage and can be higher than 45% U_n , but duration of release impulse T_{ir} , should be chosen from the following diagram, to avoid re-operate of the relay.

When the relay shall be released with rated coil voltage U_n one external resistor R (see coil energizing data and driving circuits) must be included in release circuit.

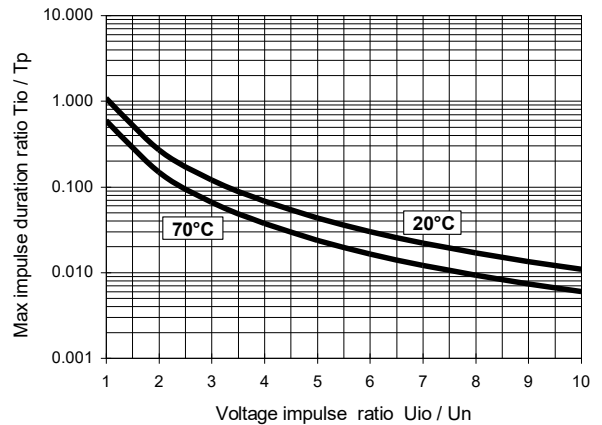

Minimum impulse duration for operating

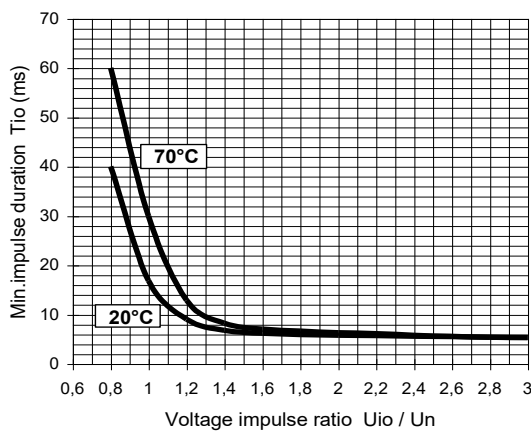

Minimum impulse duration for releasing

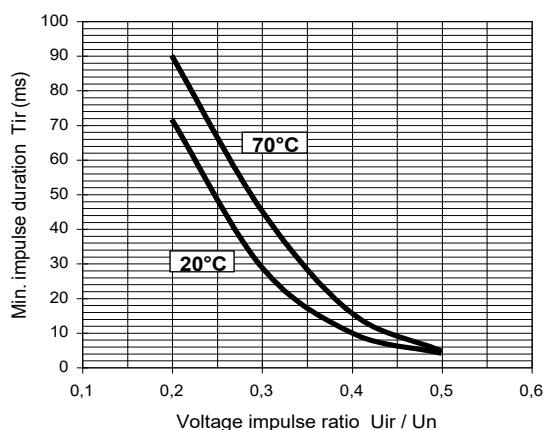

To prevent overheating of the coil at impulse energizing, the operate impulse duration ratio T_{io}/T_p must not exceed limit regarding to the operate voltage ratio U_{io}/U_n - see the following diagram.

Min. periode duration $T_p = 2s$ (1.25 A) and $6s$ (3A)

Maximum impulse duration ratio for operating

Other data

Test voltage (1 min)	
coil-contact:	1000 V_{rms} , 50 Hz
contact-contact:	750 V_{rms} , 50 Hz
Rated impulse voltage (1,2/50) μs :	1500 V_{imp} (coil-contact)
Overtoltage category:	II, IEC 60664-1
Degree of pollution:	2, IEC 60664-1
Operate time:	abt. 5 ms
Release time:	abt. 4 ms
Insulation resistance (500 VDC):	$> 10^3$ $M\Omega$
Vibration resistance (10-55Hz):	10g, IEC60068-2-6
Shock resistance (11 ms)	
functional:	10g, IEC60068-2-27
destructive:	100g
Ambient temperature	
for operating:	- 40°C to + 70°C
for storage:	- 40°C to + 85°C
Protection degree:	IP 67, IEC 529
Seal test: (1 min)	Qc/2, IEC 60068-2-17
Flammability class:	V-0, UL 94
Mounting position:	optional
Relay weight:	4.5 gr

Max. switching capacity, resistive DC load

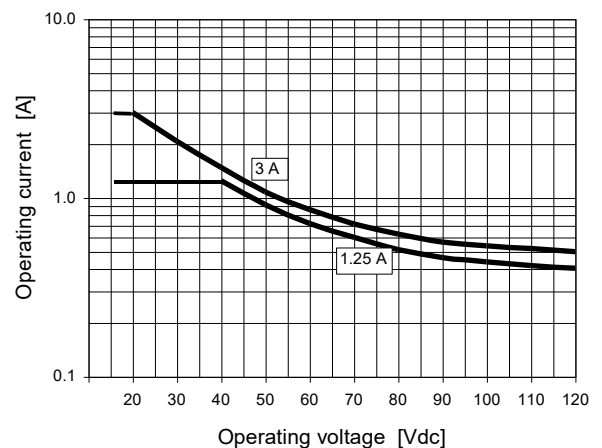

Electrical life at resistive AC load

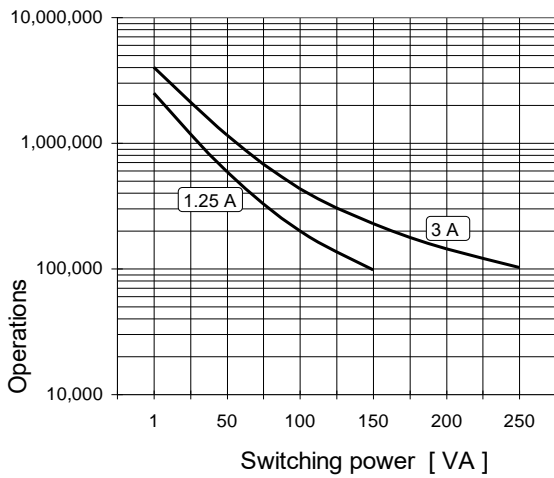

Electrical life at resistive DC load

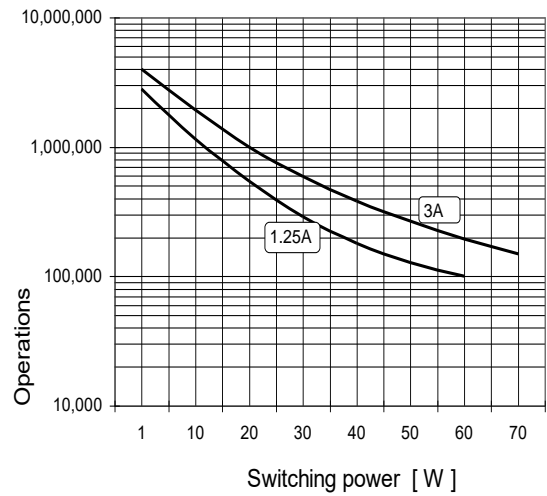

Ordering data

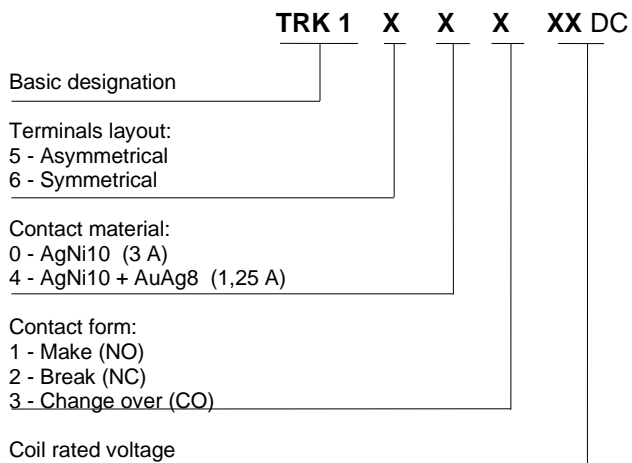

Recommended driving circuit

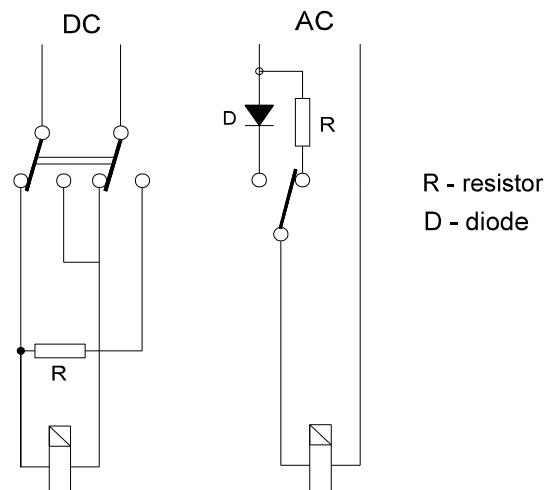

Dimensions and terminals layout

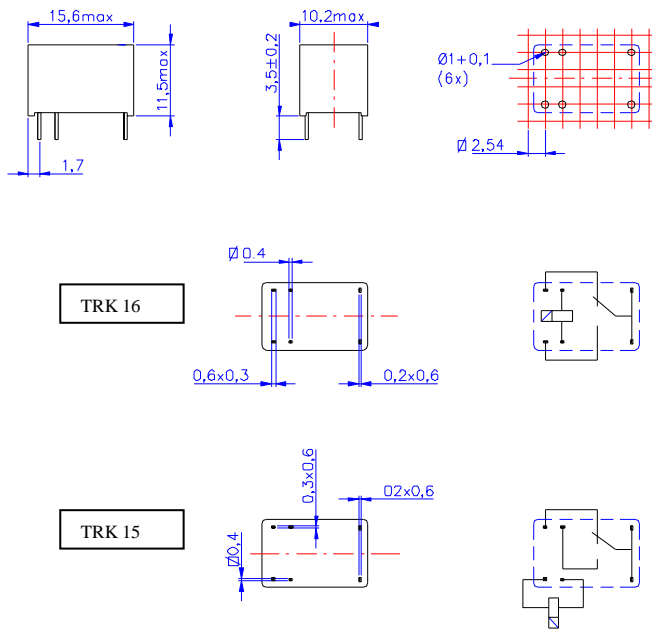

Packing information

Relays supplied in re-usable and PVC free bar packing.
 Bar length: 420 mm.
 Contents: 25 relays.

ISKRA-RELEJI d.d.

Štatenberg 88,
 SI- 2321 Makole
 SLOVENIA

Commercial department

Tel.: +386 2 803 10 20, Fax: +368 2 803 10 21

E-mail: sales@iskra-releji.si

Producer reserves all rights to alter characteristics at any time without notice. Producer assumes no liability for damage to people or things, caused as a result of the incorrect use or application of its products. All Rights Reserved.